



WITTENSTEIN

move

The magazine for customers and partners of WITTENSTEIN AG

mechatronic drive technology –
thinking fast forward

cymex® 5 opens up new horizons
for drive design

move

The magazine for customers and partners of WITTENSTEIN AG

Contents

Masthead

Publisher:
WITTENSTEIN AG
Walter-Wittenstein-Str. 1
97999 Igersheim / Germany
Phone: +49 7931 493-0
www.wittenstein.de
move@wittenstein.de
Editorial content:
Sabine Maier,
Manager Press & Public Relations
(Responsible under press law)

Issue:
16 / April 2016
Circulation:
German: 4500 copies
English: 1800 copies
Production:
IMMAGIS
Franziskanergasse 1
97070 Würzburg / Germany

Picture credits:
Pages 14-17: F. Zimmermann GmbH (3)
Page 19: DMT Drehmaschinen GmbH
Page 25: SECKLER AG (1)

All rights reserved. This document may not be reprinted or electronically distributed without the express permission of the publisher.

- 4 cymex® 5 opens up new horizons
WITTENSTEIN Group
- 10 Electromobile drive technology
WITTENSTEIN Group
- 14 Rack-and-pinion system for linear motion control
WITTENSTEIN alpha GmbH
- 18 Galaxie® Drive System “gets the right twist”
- 20 When servo technology offers crystal clear benefits
WITTENSTEIN cyber motor GmbH
- 24 TPM+ servo actuators enhance performance
WITTENSTEIN motion control GmbH
- 26 Bespoke gearheads from a single supplier
WITTENSTEIN bastian GmbH
- 30 No chance for germs
Hygienic design by WITTENSTEIN
- 34 On the road in Peru
- 38 Trade fair calendar 2016



Dear readers,

►► If you press this button on your DVD player, it means you want to “fast forward”. Our motto for the Hannover Messe 2016 describes the forces that drive us forward. The ability to anticipate tomorrow’s developments today and shape the future by pioneering new technologies: “mechatronic drive technology – thinking fast forward”. We look forward to introducing you to an exciting mix of topics at our booth in Hall 15, Stand F08, which will once again underline our claim to be a driver of innovation in mechatronic drive technology.

cymex® 5, our completely revised sizing software, now includes a powerful “Optimizer”. The bottom line: a time saving of up to 60% for your designers to calculate possible variants! The first lead customers have already confirmed that three years of intensive development work were worth the effort.

Satisfied customers – you – laid the foundation for our success in the fiscal year just ended: we are proud to report new record sales in the region of 300 million euros. We have continued to grow worldwide and we now employ more staff than ever before. A new subsidiary was recently established in Turkey, for example.

Professor Dieter Spath
Chairman of the Board and CEO WITTENSTEIN AG

When the Hannover Messe opens its doors, the new WITTENSTEIN fiscal year 2016/17 will be just a few weeks old. Our crystal ball reveals rather blurred business prospects for the future – in today’s difficult international climate it is all the more important for a family owned firm like the WITTENSTEIN Group to face the complex challenges optimally equipped. On April 1, 2016, the Management Board was supplemented by four new members, all internal appointees: Dr. Anna-Katharina Wittenstein, Dr. Dirk Haft, Erik Roßmeißl and Dr. Bernd Schimpf.

Together with Karl-Heinz Schwarz, I have been paving the way for this generational change in leadership over the last few years. On March 31, Mr. Schwarz stepped down from the Management Board and has now left the company after almost thirty years. His contribution to the WITTENSTEIN Group’s globally visible success is grounded to a large extent in his extraordinary humanity, dedication and loyalty during the last three decades. I too plan to relinquish my Board responsibilities in the autumn – by then, my role at WITTENSTEIN as a “bridge-builder for the next generation at a successful family run firm” will have been fulfilled.



cymex® 5 opens up new horizons for drive design

Developed and thought through to the last detail by WITTENSTEIN alpha, tested by lead customers and judged to be perfect – cymex® 5, the new sizing software, is exactly what users have been longing for.

The diverse functions of cymex® 5 allow drive trains to be engineered with unbeatable efficiency. Felix Zeeb, a mechanical engineer at OPTIMA consumer GmbH and one of the lead customers who agreed to test the software thoroughly upfront of the market launch, will testify to this: “cymex® 5 is efficiency engineering. To me, it means clear structures, clear specs, a clear goal, simple and intuitive to use – and fun.”

Several possible entry levels, multiple design options

Users can choose between several possible entry levels when they embark on a design project. “You can get started with the software via the motion profile, for instance, the load case or the mechanism of a machine”, explains Timo Markert, Product Manager at WITTENSTEIN alpha and one of the software’s chief architects. “It enables precise simulations of motions and loads because you can select all a drive’s most common basic applications as well as the most frequent movement kinematics and machine mechanisms directly. A crankshaft, telescope and centre winder are now integrated over and above the applications already implemented in cymex® 3.” cymex® 5 makes the designer’s work much easier because several axes and variants can now be analyzed and evaluated simultaneously in a single project – a time saving of up to sixty percent. This is a crucial

argument for Jürgen Blümel, System Development Filling Machines at SIG Combibloc Systems GmbH: “cymex® 5 gives us significantly more options. We can map several axes at once. The software is a quantum leap. In the past, each axis was separate, which meant first one file, then the next, with data all over the place. Today, we can define and save the complete machine in a single project file – it’s perfect.”

Customizable and intuitive

With cymex® 5, each user can design and save their “own” GUI layout with different windows and freely positionable toolbars intuitively and individually. Max Windholz, Senior Manager Standardization at SOMIC Verpackungsmaschinen GmbH & Co. KG, cannot praise the ease of use too highly: “I like the cymex® 5 GUI a lot. You get used to it very fast. It’s very intuitive. For ordinary users who work with it every day, it’s brilliant.”

The cymex® 5 success formula

To support the configuration of drive trains, cymex® 5 has access to a regularly updated database containing around 14,000 motor versions from more than 50 different manufacturers plus more than 8000 WITTENSTEIN alpha gearheads and 200 combinations of

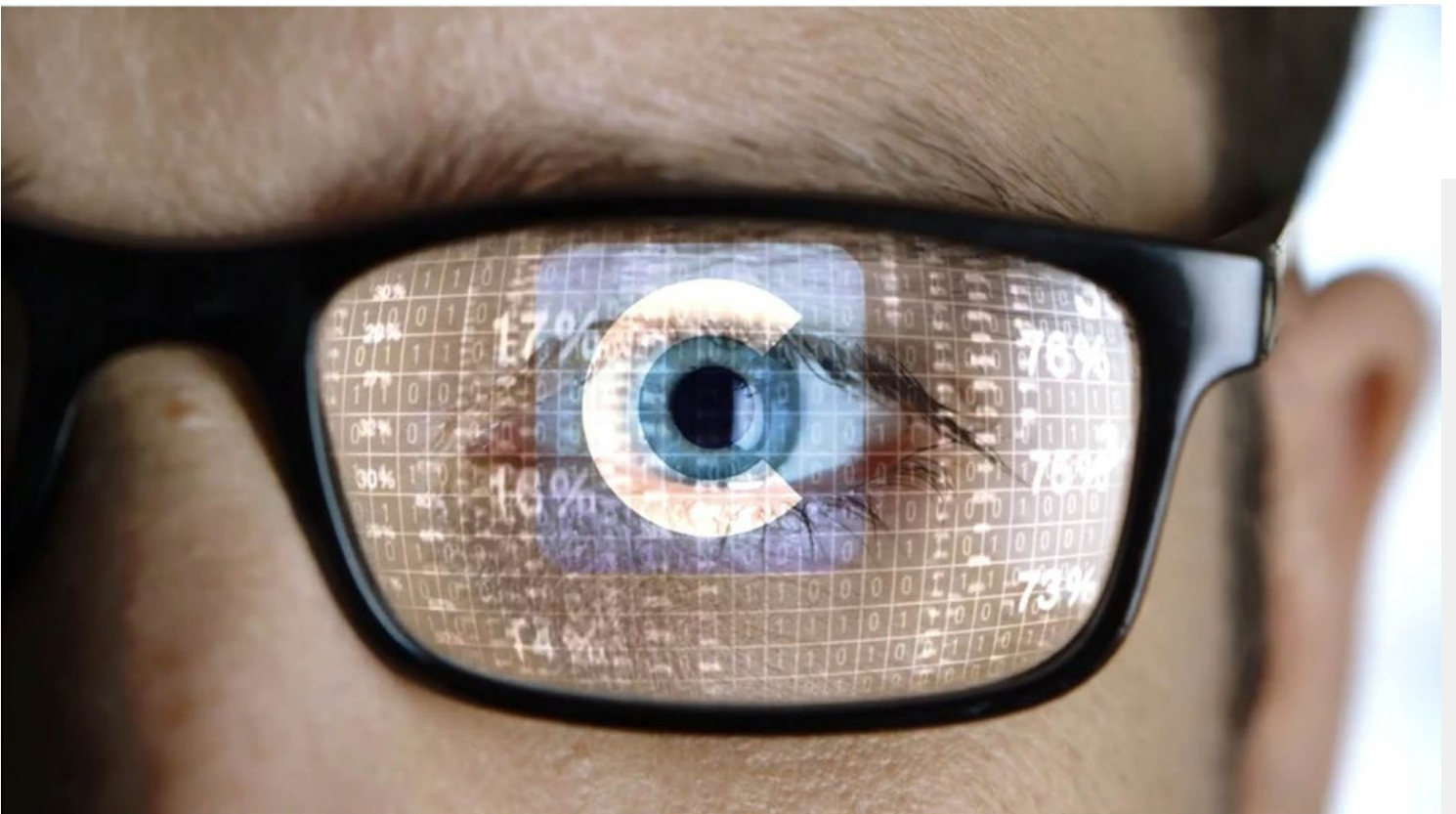

WITTENSTEIN linear systems. It isn't just this huge database that is responsible for the functionally optimized drive trains which can now be designed with cymex® 5, however; WITTENSTEIN can also draw on more than thirty years of expertise in drive technology. Felix Breitmar, System Development Filling Machines at SIG Combibloc GmbH, clearly notices the benefits of this interaction whenever he works with the sizing tool: "In my opinion, it makes a big difference that all of WITTENSTEIN's experience has gone directly into the software. And I also find it fascinating that everything was developed in-house, to leverage the full advantage of that amassed experience."

Master-slave function for sizing mutually tensioned drives

The fundamentally new master-slave function, so far exclusive to cymex® 5, is a good example here. Two electrically preloaded drives can now be mapped for the first time. "The mutual tensioning between the master and slave eliminates backlash in the drive train, increases the machine's stiffness and ultimately also lets you design it with higher dynamics", Timo Markert explains.

Drive design without language barriers

cymex® 5 can be used in any of eleven European and Asian fonts or languages. The calculation documentation and product data sheets reflect this impressive linguistic diversity. This is a significant aspect for Nils Varrelmann, a mechanical designer at Broetje Automation GmbH: "The more languages are available, the better it is for us and our end customers. China is currently a very big market for us and so are Japan and the U.S. That's why internationality is particularly

important when it comes to drive design and documentation – and that's what we get from cymex® 5."

"Optimizer" for more power density and energy efficiency

cymex® 5 is shipped with an "Optimizer" that is the only one of its kind to date for sizing software. Timo Markert: "If you want to identify downsizing potential, you can read out a machine's existing controller parameters, import them into cymex® 5 and optimize the drive train's energy efficiency". Furthermore, in specific load cases, the Optimizer also knows whether a smaller sized motor / gearhead unit could be used instead, for example, without compromising performance.

User friendliness, versatility, internationality,
downsizing, energy efficiency –
that's what the cymex® 5 sizing software
is all about.



1 The cymex® 5 sizing software is a new, multifunctional tool that enables bespoke drive trains to be designed reliably, economically and energy efficiently.

2 Drives optimized for specific loads and motions are designed with unerring reliability with cymex® 5 – with information, warnings and error messages if individual components are overloaded, for example.

3 With cymex® 5, each user can design and customize their own GUI layout with optional windows and freely positionable toolbars. This personal look & feel can also be saved permanently as the default for follow-up projects.

4 The optional “Optimizer” – the only one of its kind in sizing software – identifies downsizing potential and permits more energy efficient drive trains.

Up to 60% time saving

cymex® 5 makes the designer’s work much easier because several axes and variants can now be analyzed and evaluated simultaneously in a single project – a time saving of up to sixty percent.

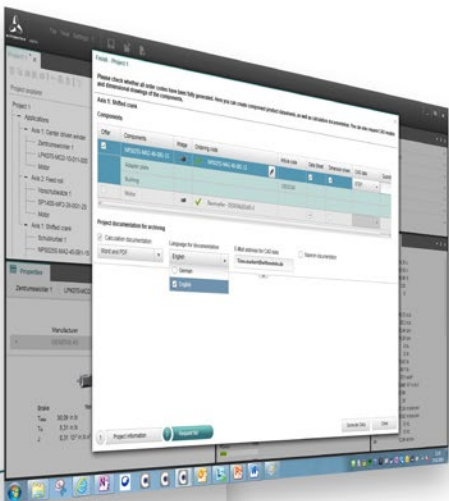
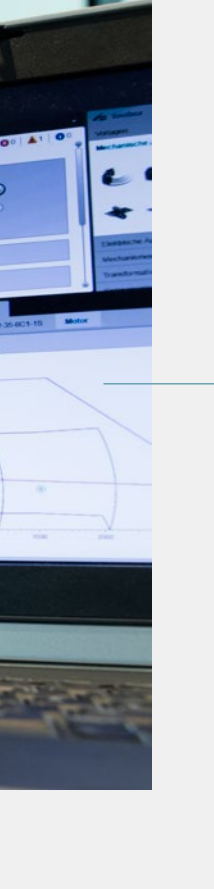

7



6

5 Thanks to the Profiler function in cymex® 5, the input parameters of motion profiles can be described in detail and motion and load data represented on a graph.

6 Complete and always up to date: the cymex® 5 database comprises around 14,000 motor versions from more than 50 different manufacturers plus more than 8000 WITTENSTEIN alpha gearheads and 200 combinations of WITTENSTEIN linear systems with all relevant technical specifications.

7 At the end of the sizing process, the user can generate the complete calculation documentation directly, create data sheets and display 2D or 3D CAD data of selected components – in any of eleven different languages.



Tested by lead customers and judged to be perfect: **cymex® 5**

Jürgen Blümel, SIG Combibloc:
“cymex® 5 is a quantum leap.”



Max Windholz, SOMIC:
“I like the cymex® 5 GUI a lot. You get used to it very fast.”

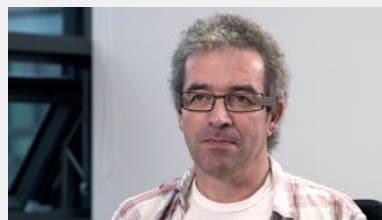

Felix Breitmar, SIG Combibloc:
“In my opinion, it makes a big difference that all of WITTENSTEIN’s experience has gone directly into the software.”



Nils Varrelmann, Broetje Automation: “Internationality is particularly important for us when it comes to drive design and documentation.”

»cymex® 5 marks a quantum leap in terms of user friendliness and performance compared to all other tools currently available in the market.«

STEFAN HIRTH,
HEAD OF PRODUCT MANAGEMENT, WITTENSTEIN ALPHA GMBH

[move talks to:](#) Stefan Hirth, Head of Product Management,
WITTENSTEIN alpha GmbH

Product Manager Timo Markert holds regular consultations with Elena Albert, the application engineer responsible for cymex®'s technical specification at WITTENSTEIN alpha. Market and customer requirements are reconciled in this way with technology know-how.

What are the reasons for cymex® 5's completely revised design?

Back in 1999, WITTENSTEIN alpha was the first company to provide users with intelligent software for designing gearheads in drive trains. We also pioneered sizing tools. cymex® has been regularly extended and upgraded over the years, of course. It's always a special honour for a product if market competitors copy it more or less identically, which is what happened with cymex® 3. The requirements a sizing tool is expected to meet change as time goes by, and we've listened very carefully to what our customers want with regard to graphical interfaces, ease of use and new, integrated technologies. cymex® 5 is the answer and it marks a quantum leap in terms of user friendliness and performance compared to all other tools currently available in the market.

What is it that makes cymex® 5 a particularly attractive and reliable sizing tool for users?

The added value for our customers is enormous if not just individual components but the complete drive train can be considered for their very specific use case. cymex® 5 gives users a detailed calculation of all components and interfaces in the train. It also calculates shafts and bearings, for instance. It's this holistic approach that allows the machine to be tuned and tweaked for the best possible performance. Moreover, cymex® 5 guarantees exceptional reliability throughout the design process.

How does that work?

Thanks to an ingenious support function, users see information on exact-fit components as soon as they enter a value, for example. A message is displayed if the drive is over- or undersized or if an input is incorrect. Even novice users get fast, robust results in this way, plus the security of knowing that the design matches their requirements.

How much time can customers and users actually save in practice?

Unlike other sizing tools, cymex® 5 can define any number of axes at once. That alone can reduce the time to calculate variants by as much as sixty percent. And when you add that to the impressive ease of use and intuitive features, it's not difficult to understand why cymex® 5 is such a high performance tool. In a benchmark test with conventional software solutions, cymex® 5 was up to ninety percent faster. Users are really excited about that.

What do customers and users have to do to take advantage of cymex® 5?

We at WITTENSTEIN attach great importance to top quality advice and support that help our customers get the best out of our products. cymex® 5 was developed for precisely that purpose and all users profit from a free basic version with extensive functionality. All they have to do is download it from the Internet. We can also include customer-specific Premium functions like the master-slave option or the Optimizer in cymex® 5. In this case, we provide appropriate training, of course, to make sure everyone can use these functions efficiently. Here, too, cymex® 5 sets new benchmarks.

Electromobile drive technology

WITTENSTEIN in the pole position



Calculation of the complete, electrified drive train – WITTENSTEIN convinces with this approach as an innovation and technology partner for a wide range of electromobile vehicle concepts, from the research project through the development phase to readiness for series production. The [world record-breaking electric go-kart](#), the [BMW C evolution electric maxi scooter](#) or the [Mercedes Benz SLS AMG Hybrid](#) – all of these vehicles illustrate clearly how sizing electric powertrains has emerged as one of WITTENSTEIN's core competencies.

Partner from research project to series production

It was in 2005 that WITTENSTEIN laid the foundation for a rich pool of expertise by developing the first electric powertrains, which have since become one of the company's core competencies. "Today, our know-how encompasses quite a few technologies and processes that enable significantly shorter lead times", explains Dr. Kay-Horst Dempewolf, Head of Development Automotive & Servo Drives at WITTENSTEIN cyber motor GmbH. "Together with the high flexibility and speed of proven internal project structures, this means just six months from debating the initial concept for a novel drive

architecture with the customer to the first hardware." A successful prototype phase then generally marks the entry into small-volume production.

Motor, gearhead, electronics, software – powerful subsystems optimized as a complete solution

When a vehicle's drive train is electrified, it's only at first glance that everything centres on the motor and the gearhead. "As far as the actual drive is concerned, we favour permanent magnet synchronous motors for use in two and four-wheeled electric vehicles", adds



Awe inspiring: The world record-breaking electric go-kart accelerates from 0 to 60 mph (approx. 100 km/h) in just 2.635 seconds.

**Delight among the project partners
at the new world record:**

The electric go-kart was developed by a consortium comprised of WITTENSTEIN cyber motor, the Institute for Management and Engineering at Osnabrück University of Applied Sciences in Lingen (Ems) and H-Tech AG of Schaan (Liechtenstein).



Dr. Ingolf Gröning, General Manager of WITTENSTEIN cyber motor. "They convince with their high efficiency, light weight and almost silent running – and they've also already proved their efficiency and their suitability for everyday use." Yet the electronics and the software are just as vital when designing such high performance traction drives – because they are what make electric drive technology so incredibly intelligent, efficient, reliable and safe. "That's why it's important to consider the electric powertrain as a system in every single project. Not only the motor and the gearhead but also the electronics and the software have to interact optimally. At the same

time, they must be easy to integrate in the vehicle control system in question as well as in new vehicle concepts", comments Dr. Thomas Kalker, General Manager of WITTENSTEIN electronics. "Throughout the Group we're in a perfect position to apply this holistic approach."

Electromobility needs drive technology in "space optimized power density"

Electromobile drive solutions must combine maximum power density with the ability to fit into the most diverse mechanical geometries. Special calculation and sizing tools are used to systematically reduce

The electric go-kart was manufactured by students of Mechanical and Business Engineering at Osnabrück University of Applied Sciences in north Germany. They were supported by engineers at WITTENSTEIN cyber motor, who developed the electric motor.

World record-breaking electric go-kart



»Our motors convince with their high efficiency, light weight and almost silent running.«

DR. INGOLF GRÖNING,
GENERAL MANAGER, WITTENSTEIN CYBER MOTOR GMBH

„Sheer Driving Pleasure“:

In the BMW C evolution electric maxi scooter (shown here without the fairing) a 48 hp servo motor and WITTENSTEIN power electronics achieve acceleration from 0 to 50 km/h in 2.7 seconds. The time to reach 100 km/h is a phenomenal 6.2 seconds.

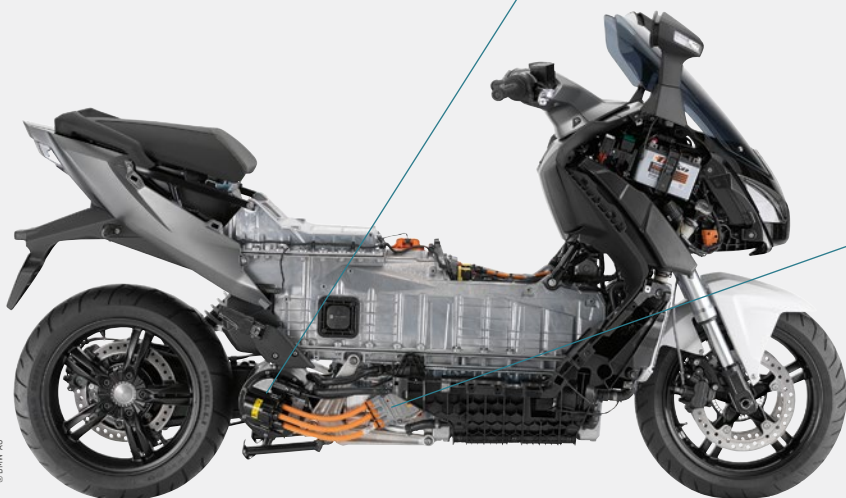

C evolution electric maxi scooter
built by BMW Motorrad

the volume of the electric drive to a minimum. The second essential aspect is the drive's power per weight ratio. Special materials are an effective way to optimize this parameter. Dr. Thomas Kalker: "We utilize special sheets, for instance, or plastic bonded metal particulates for the electric drive and new semiconductor materials like silicon carbide for the drive electronics". Smart solutions to cool the drive electronics also have a positive impact on the power per weight ratio. Specially designed cooling structures with surfaces that are optimized with respect to fluid mechanics dissipate heat selectively from the power modules. "We can build a more compact heat sink as a result, and that saves both space and weight", says Dr. Thomas Kalker.

Extensive, tightly interconnected core competencies in the areas of motor and gearhead sizing and power electronics are necessary to develop, optimize and manufacture electric powertrains for use in vehicles. With numerous successful reference projects, WITTENSTEIN is demonstrably the perfect partner – from the preliminary research to series production.

Mercedes Benz SLS AMG Hybrid



A highly dynamic electric motor developed by WITTENSTEIN cyber motor for a Mercedes Benz SLS AMG has an output of 123 kW and is incorporated in a revolutionary, high performance gearbox with an integral hybrid drive.

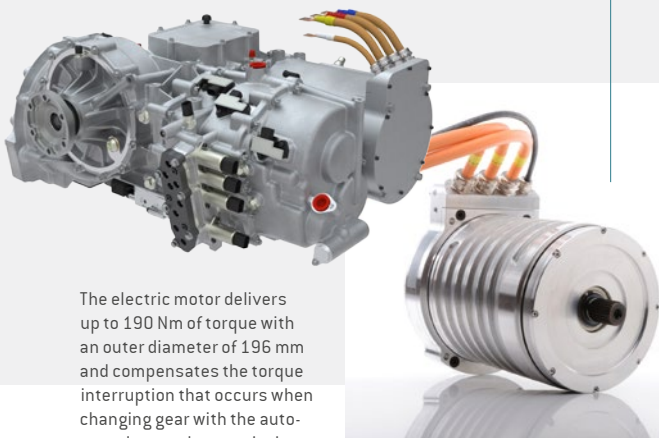

The electric motor delivers up to 190 Nm of torque with an outer diameter of 196 mm and compensates the torque interruption that occurs when changing gear with the automated manual transmission.

Successful eMobility with WITTENSTEIN

WITTENSTEIN AG is a high-end partner for the development and manufacture of high performance electromechanical motors for use in electric and hybrid vehicles. Several prestigious – and in some cases record-breaking – projects are glowing testimonials. The electric go-kart, for instance – developed by a consortium comprised

of WITTENSTEIN cyber motor, the Institute for Management and Engineering at Osnabrück University of Applied Sciences in Lingen (Ems) and H-Tech AG of Schaan (Liechtenstein) – “catapulted” WITTENSTEIN cyber motor into the Guinness Book of Records: on September 23, 2015, it accelerated from 0 to 60 mph (approx. 100 km/h) in just 2.635 seconds, setting a new world record for electrically powered carts. WITTENSTEIN has enjoyed similar success in the last few years on eMotorcycle racetracks: as a development partner of the Münch Racing Team, the company played a key role in winning the World Championship in 2010 and 2011.

In the BMW C evolution electric maxi scooter a 48 hp WITTENSTEIN motor guarantees “sheer driving pleasure”: it achieves acceleration from 0 to 50 km/h in 2.7 seconds while the time to reach 100 km/h is a phenomenal 6.2 seconds. “This project successfully demonstrated our expertise from the initial drive concept right through to series production”, Dr. Kay-Horst Dempewolf asserts. “WITTENSTEIN has mastered the transition from research to series partner with flying colours.”

In a project with Oerlikon Graziano and Vocis Ltd., its British subsidiary, WITTENSTEIN cyber motor developed a highly dynamic electric motor with an output of 123 kW for incorporation in a revolutionary, high performance gearbox with an integral hybrid drive installed in a Mercedes Benz SLS AMG. This electric motor delivers up to 190 Nm of torque and compensates the torque interruption that occurs when changing gear with the automated manual transmission.

“These projects show how very diverse applications in electromobile drive technology can be”, Dr. Kay-Horst Dempewolf concludes.

The engineers can produce a scale image of a vehicle long before it rolls off the conveyor belt. The first such prototype is often made on a portal milling machine from F. Zimmermann GmbH. An HPLS rack-and-pinion system built by WITTENSTEIN alpha guides the cutting head over the workpiece with extreme precision, smoothness and dynamics.

Linear motion control as a high-end system solution

Zimmermann's new FZ37 portal milling machine meets all of the requirements for innovative milling solutions.

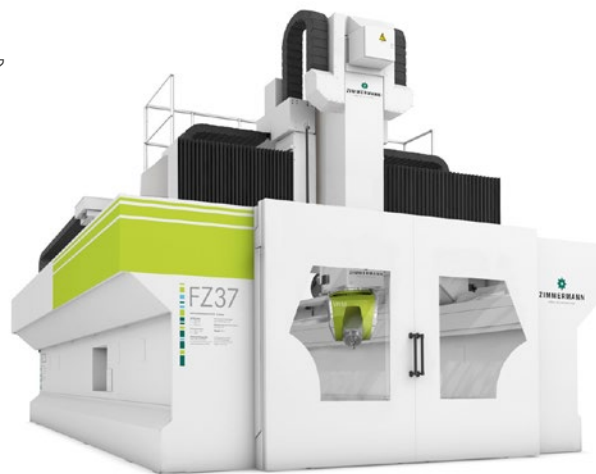

FZ37 – this is the name given to the newest generation of portal milling machines from F. Zimmermann GmbH. They are capable of cutting not only light alloys, plastics and composite materials but also steel and cast iron with micrometre accuracy in a 5-sided multi-axis machining operation. Even very complex shapes can be milled from a block of material in just a short time. Hartmut Kälberer, President of Zimmermann, explains what matters most to his customers in the automotive, aerospace and toolmaking industries or the railway and energy sectors: “Speed, dimensional accuracy and surface finishes of a very high quality are typical expectations for milling solutions along with versatility and flexibility”.



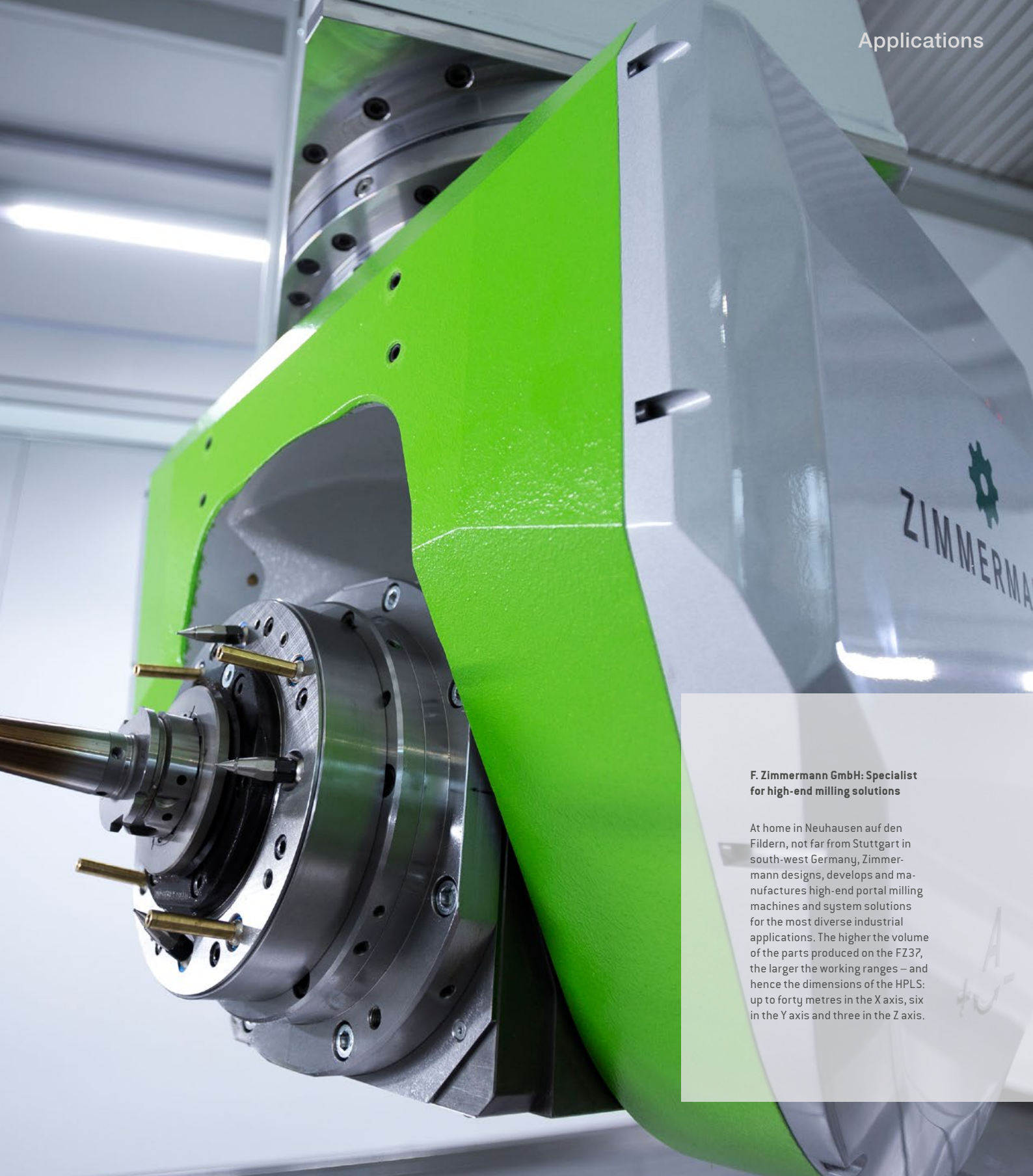

F. Zimmermann GmbH: Specialist for high-end milling solutions

At home in Neuhausen auf den Fildern, not far from Stuttgart in south-west Germany, Zimmermann designs, develops and manufactures high-end portal milling machines and system solutions for the most diverse industrial applications. The higher the volume of the parts produced on the FZ37, the larger the working ranges – and hence the dimensions of the HPLS: up to forty metres in the X axis, six in the Y axis and three in the Z axis.

Light alloys, plastics, composite materials, steel or cast iron – with the FZ37, delicate precision or surface machining is ensured regardless of the material.

Applications

Zimmermann's new FZ37 portal milling machine meets even the highest requirements for innovative milling solutions – and for more than a decade now the company has trusted in rack-and-pinion systems from WITTENSTEIN alpha. “The High Performance Linear System unites harmony, precision, power density and stiffness for even the most complex linear motion controls”, says Guido Brenner, Manager of the WITTENSTEIN alpha Sales Office South-West. This is possible because all its components interact optimally. The best possible performance is achieved in terms of torque and holding torque for feed and acceleration, smooth running, power density, freedom from backlash and system rigidity. Hartmut Kälberer agrees absolutely: “As far as these relevant parameters are concerned, the HPLS performs significantly better than the market standard”.

HPLS guarantees maximum portal milling performance

The integration of the HPLS in all three axes of the FZ37 enables decisive improvements. Guido Brenner sheds light on the technical

issues involved: “The high torsional and tilting rigidity of the RP⁺ planetary gearhead and the stiff connection to the machine reduce the position error to a minimum. In combination with the rack's remarkable precision this results in an extremely stiff machine structure and hence very high system rigidity over the entire axial length of the FZ37.” All axes simultaneously profit from the high speeds. Finally, the machine's true-to-path motion system ensures exceptional precision with a volumetric accuracy of up to 55 µm.

Optimized design and energy efficiency

The RP⁺ gearhead for the Z axis is designed to completely absorb all forces acting on it. “That's why we were able to build the machine without hydraulic weight compensation”, says Hartmut Kälberer. “The FZ37 needs fewer parts because of this. It's easier to control and much more straightforward to install and maintain. Furthermore, the better efficiency means ongoing energy costs are lower than with either the hydraulic concept or alternative solutions with a linear motor.”





A Zimmermann portal milling machine in action



From delicate precision machining to surface machining over a large area – thanks to the High Performance Linear System HPLS from WITTENSTEIN alpha, the FZ37's linear motion control system meets every one of the performance and quality requirements.



The FZ37 allows 5-sided multi-axis machining, so that even very complex shapes can be milled from a block of material in just a short time.

»The high torsional and tilting rigidity of the RP⁺ planetary gearhead and the stiff connection to the machine reduce the position error to a minimum.«

GUIDO BRENNER, MANAGER SALES OFFICE SOUTH-WEST, WITTENSTEIN ALPHA GMBH



The HPLS rack-and-pinion system is comprised of an ultra-low-backlash planetary gearhead with a welded, helical-toothed pinion and a precision manufactured rack.

High Performance Linear System

"As far as the relevant parameters are concerned, the WITTENSTEIN alpha HPLS performs significantly better than the market standard", confirms Hartmut Kälberer, President of F. Zimmermann GmbH (left) in conversation with Guido Brenner, Manager of the WITTENSTEIN alpha Sales Office South-West in Ludwigsburg (right).

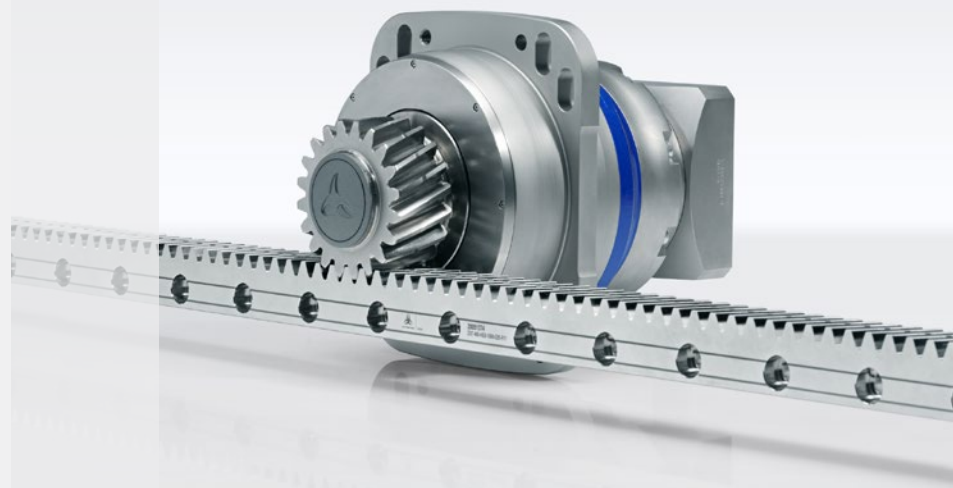

Higher metal removal rate, more flexible processes, no need for rechucking, a longer tool life and significantly better machining quality – **DMT lathes** profit in a number of ways from the unprecedented torsional stiffness and absolutely backlash-free kinematics of the WITTENSTEIN Galaxie® Drive System.

Galaxie® Drive System »gets the right twist«



Dynamic teeth grouped around an input polygon are the hallmark of the new gearhead kinematics. The Galaxie® Drive System fuses a brand new gearhead generation with a newly developed high performance motor to obtain an ultra-compact hollow-shaft drive system with integrated Industry 4.0 connectivity.

DMT lathes are the solution of choice whenever single components have to be fabricated quickly and extremely precisely. According to Friedrich Spohn, Managing Director of DMT Drehmaschinen GmbH, “Machining high quality materials – and responding to customer demands for ever higher precision – presents new challenges for the existing machine technology”.

The challenge:

Maximum precision for dynamic positioning

An analysis of the traditional milling processes identified torsional stiffness and the backlash of the main motor / gearhead unit as decisive parameters because they have a significant impact on the dynamic positioning accuracy. Friedrich Spohn explains the background: “This, in turn, is one of the keys to machining quality, a longer tool life and higher metal removal rates by the equipment during machining operations with the C axis”. The decision to install the Galaxie® technology was swayed firstly by the enormous torsional rigidity and the absolute freedom from backlash while secondly, the

compact design of the Galaxie® Drive System permitted relatively easy integration into the existing machine concept.

The outcome:

More productivity thanks to better torsional stiffness and permanent freedom from backlash

Since switching to the revolutionary gearhead kinematics, DMT lathes have benefited from a substantial gain in performance during milling operations with the C axis. Their machining times are now shorter and this has played a vital part in boosting productivity. Amongst other things, the higher metal removal rates result from the fact that even larger workpieces can now be produced in one setting. Once clamped, they can also be positioned a good deal faster and more accurately. “Owing to the torsional stiffness and freedom from backlash achieved with the Galaxie® Drive System, the tool cutting edges have an extended life and lathe uptime is increased”, says Volker Sprenger, Head of Sales Galaxie Drive Systems at WITTENSTEIN, when prompted to list the advantages for DMT.

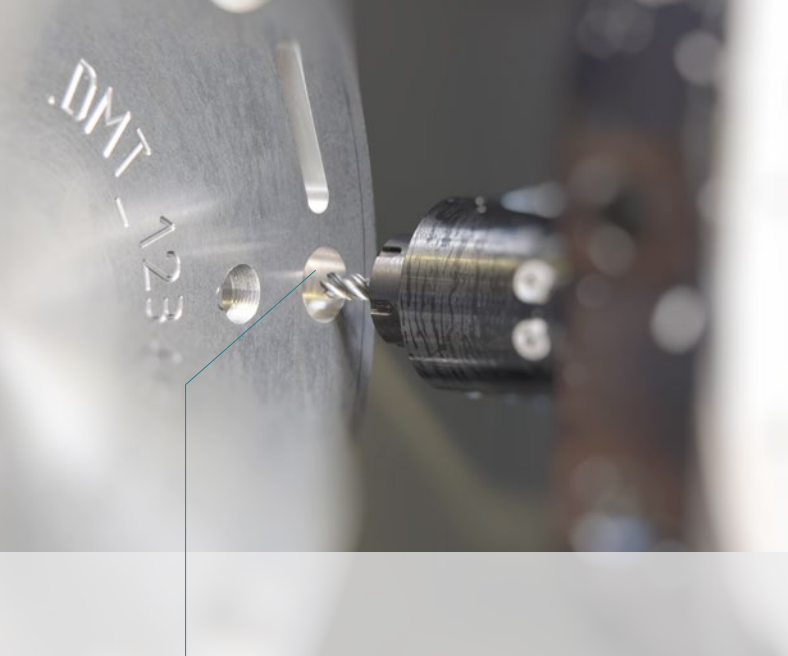

Shorter machining times, higher metal removal rates, much faster and more accurate positioning of the workpieces, an extended tool cutting edge life – DMT lathes have benefited from a substantial gain in milling performance thanks to the Galaxie® Drive System.

The Galaxie® Drive System in use at DMT meets the rigorous requirements for torsional stiffness and backlash – and hence dynamic positioning accuracy – extremely reliably.

Optionally also with interactive contour programming: The DMT portfolio of lathes for cycle controlled and CNC machining includes models with a maximum swing diameter of 280 mm to 1100 mm, centre distances ranging between 500 mm and 6000 mm and a drive power of 11.5 kW to 46 kW.



Galaxie® gearhead kinematics now also taught at colleges and universities

To coincide with the completely redesigned gearhead kinematics of the Galaxie® Drive System, WITTENSTEIN introduced the logarithmic spiral as a novel tooth geometry and a fundamentally new concept in gear design – paving the way for a brand new gearhead generation that isn't (yet) found in any textbook. In the meantime, this situation is changing: on November 13, 2015, lecturers from about twenty universities were invited to a one-day workshop at the WITTENSTEIN Headquarters in Igersheim. The aim was to discuss how the new technology can be anchored in the bachelor and master's curriculae for upcoming engineers and designers in an array of technical disciplines using modern didactic concepts. The workshop wound up with a tour of the WITTENSTEIN Innovation Factory, where Galaxie® Drive Systems are built, and at the end of the day the workshop participants were unanimous in their satisfaction with the outcomes, which will benefit both teaching and future R&D work on Galaxie® applications.

DMT: Leading international manufacturer of lathes

DMT Drehmaschinen GmbH of Lörrach, in the far south-west corner of Germany, is a leading international manufacturer of lathes for manual, cycle controlled and CNC machining as well as interactive contour programming. The portfolio of standard and special-purpose machines includes models with a maximum swing diameter of 280 mm to 1100 mm, centre distances ranging between 500 mm and 6000 mm and a drive power of 11.5 kW to 46 kW. DMT was one of the first pilot customers to use the completely backlash-free Galaxie® technology – unlocking the door to precision-turned parts of unprecedented quality.



November 2015, Zwiesel in the Bavarian Forest. The sun is shining but it's cold outside. The sales area and showroom at Zwiesel Kristallglas AG makes a striking contrast: it's comfortably warm there because several glass blowers are about to demonstrate their craft. A large lung capacity and considerable dexterity are necessary to mould hot drops into tumblers, wine glasses and vases. The visitors gaze in admiration.

They would probably be even more amazed if they could see how, only a few metres away, around sixty thousand glasses are manufactured fully automatically every single day. The temperature is no longer just warm but positively hot. There are also fine soot particles

and glass dust floating in the air, mingled with oil particles and steam – Zwiesel tumblers and wine glasses may look beautiful and elegant on the shelf in a department store or on the dining room table, but the conditions in which they're made are very harsh indeed.

Compact, ready to mount, controllable, maintenance-free and economical – at Zwiesel Kristallglas, linear actuators built by WITTENSTEIN cyber motor make glass production more efficient.

When servo technology offers crystal clear benefits

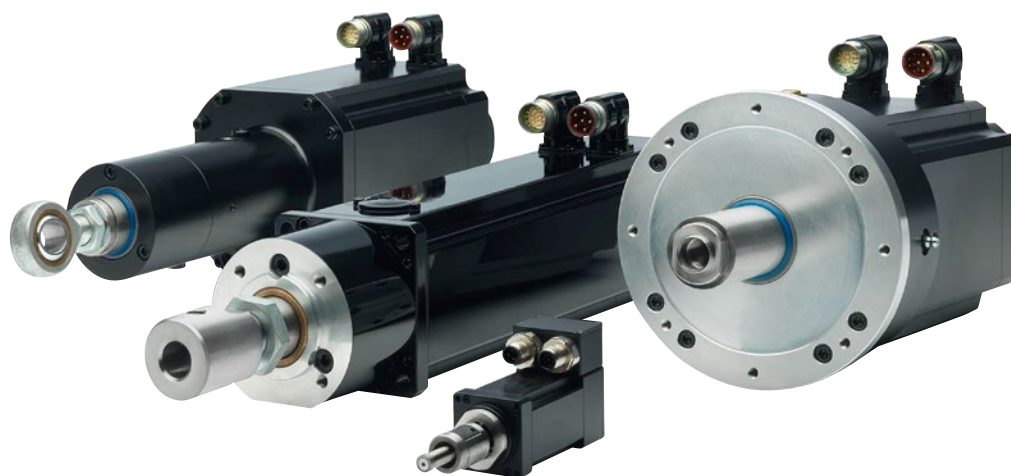

Linear actuators with an integral screw from WITTENSTEIN cyber motor are individually designed and configured based on a modular system.

Linear actuators overcome performance limits

Against this background Iprotec GmbH, a special-purpose machine-builder which was originally part of Zwiesel Kristallglas' equipment manufacturing operations, integrated custom-developed linear actuators in its production process – replacing the old pneumatics. “Before this happened, we obviously had to convince the customer that our linear actuators not only comply with all the technical requirements but are also sufficiently durable”, reports Carolin Ank, Product Manager at WITTENSTEIN cyber motor. The actuators were designed and built to be robust enough to justify switching to a fundamentally different technology. “Introducing linear actuators in a glass machine in place of energy-intensive, high-maintenance pneumatic cylinders was a major developmental advance”, explains Klaus Lesche, Technical Sales Manager Glass Machines at Iprotec. “We were hoping that the servo technology, which offers better controllability by design, and the superior integration in the higher-level controller would help us overcome traditional performance limits.”

Linear actuators: optimal performance based on a modular system

The linear actuators can be supplied in various sizes with different – even customized – flange geometries, suitable screw types, active lengths to match and the required brake

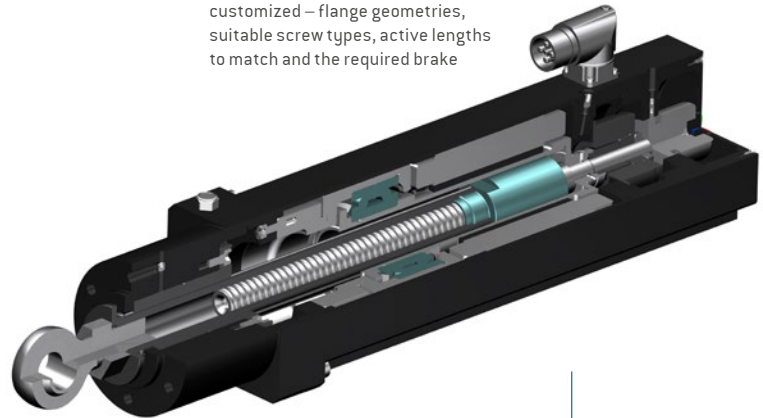

and encoder variants. The result: compact, ready-to-mount and commercially optimized solutions that are particularly effective in extreme conditions.

“Mechanical glassblowers” at work

Hot, liquid crystal glass exits from the melting furnaces at 1500°C and is portioned in feeders. The glass drop – or gob – produced in this way is received by one of two plungers while the second transfers it to the blow moulding machine after it has been pressed into tablet form. In the past, the vertical movement of the two plungers was always rigidly coupled by design. “This had two serious drawbacks: we were obliged to use expensive compressed air and the machines regularly had to be shut down due to leaks”, Klaus Lesche continues. “On top of that, we had no way of controlling the pneumatic cylinders separately in order to reduce the idle times. Unfortunately, it took just as long to move the plunger with the tablet as it did without.”

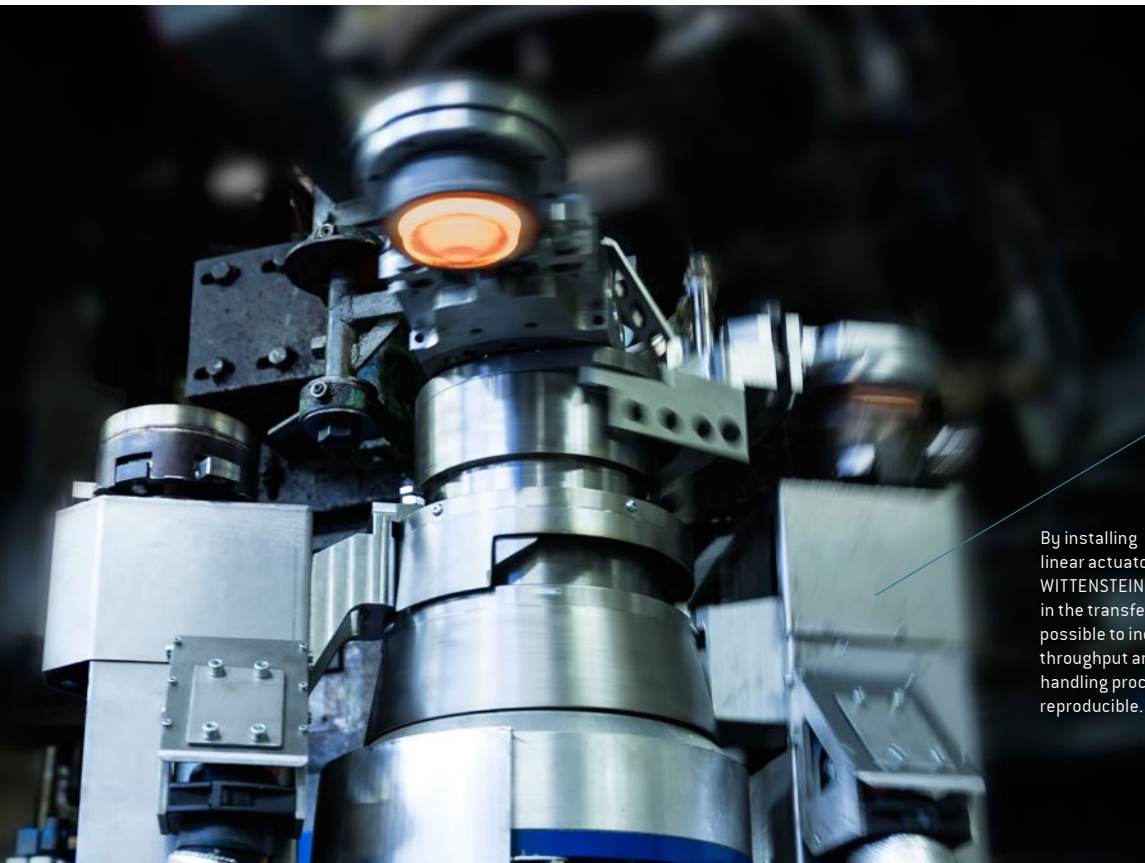

By installing linear actuators from WITTENSTEIN cyber motor in the transfer unit, it was possible to increase the throughput and make the handling process more reproducible.



Beautiful and elegant: around **60 to 70 million tumblers and wine glasses** leave the Zwiesel Kristallglas production facilities in Bavaria every year.

Linear actuators boost
performance by **20%**

“Iprotec has managed to reduce this idle time to a minimum and increase the throughput because the linear actuators are separately controllable”, confirms Jan Rohde of Technical Sales at WITTENSTEIN cyber motor. The force and speed can now be set precisely and controlled in a reproducible way. The number of gobs transferred has increased by about twenty percent as a result and the performance of the downstream blow moulding machine boosted accordingly.

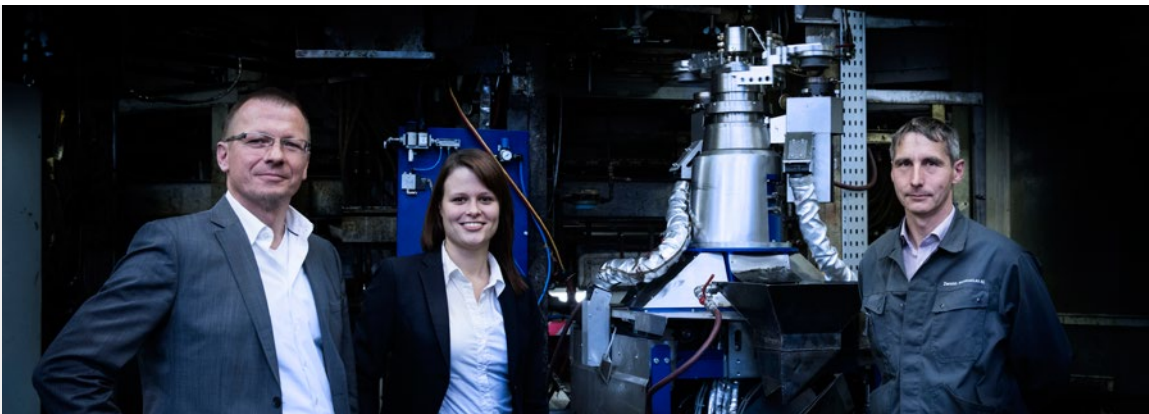

The team responsible for introducing linear actuators in the glass production process at Zwiesel Kristallglas: Klaus Lesche, Technical Sales Manager Glass Machines at Iprotec GmbH, Carolin Ank, Product Manager, and Jan Rohde, Technical Sales, both WITTENSTEIN cyber motor GmbH (from right to left).

Linear actuators take the place of pneumatics: successful technology shift means more performance in glass production.

One metre per second – that was the performance demanded.
Three metres per second – that was the performance actually supplied by WITTENSTEIN. It's simple arithmetic: workpiece machining productivity was trebled. TPM+ servo actuators built by WITTENSTEIN motion control have significantly improved the performance of SECKLER AG's brush deburrers.

Better than ordered



TPM+

WITTENSTEIN motion control's TPM+ motor / gear-head units impress with extreme compactness, high power density and reliable dynamics. Today, the TPM+ is used in more than 40,000 linear and rotary motion tasks.

SECKLER AG: Production automation, handling technology and customized mechanical engineering

From its headquarters in Pieterlen (Switzerland), SECKLER engages in international activities linked to the development and implementation of bespoke machines and systems – such as handling units for machine tools, pallet feeding, linkage and gripper systems for grinding and honing cells or special-purpose machines like brush deburrers.

"The components handled by our systems range in size from one gram to several kilograms and from one millimetre to fifty centimetres", explains Jacques Hess, Managing Director. "Our machines are used in the automotive and transportation sectors, hydraulics, pneumatics and medical technology as well as watches, jewellery and a wide range of consumer goods."

The highly compact design of the TPM+ permits space-saving integration in SECKLER deburo brush deburrers.

Jacques Hess, CEO of SECKLER, sums up: "If the individual work steps are accelerated, our throughput is higher and our running costs are lower". The faster and the more precisely the wire and abrasive brush units can be moved, especially in the X axis, the higher our brushing and deburring productivity. Yet the special dynamics were not the only challenge confronting the TPM+ dynamic and TPM+ power servo actuators.

A new dimension in dynamics and power

The brush deburrers in the deburo series were specifically developed for surface finishing in linear or rotary indexing processes. They are individually integrated in the customer's work steps and processes following machining operations such as milling, turning, grinding or honing. "When we designed an automatic fine deburring machine for hobbing workpieces, the customer specified a speed of one metre per second", Jacques Hess recalls. "That meant the servo actuators in the three machine axes had to meet certain dynamics requirements that the existing motor / gearhead units were unable to fulfil." And that wasn't the only problem: "At the same time, the motor / gearhead units had to have an extremely short overall length and run very quietly", adds André Müller, a sales engineer at WITTENSTEIN AG in Grüşch (Switzerland).

TPM+ dynamic and TPM+ power meet all performance requirements

TPM+ servo actuators from WITTENSTEIN motion control were the perfect answer. "They're used at SECKLER as a rack-and-pinion solution that meets the specified performance criteria reliably and controllably", André Müller continues. To begin with, their power density is excellent. It's achieved with the help of a special design principle: the sun wheel of the gearhead is pressed directly into the motor shaft. The mounting dimensions of the servo actuators are much, much smaller as a result – with a total length saving of around fifty per cent. The helical toothing in the gearhead guarantees exceptionally

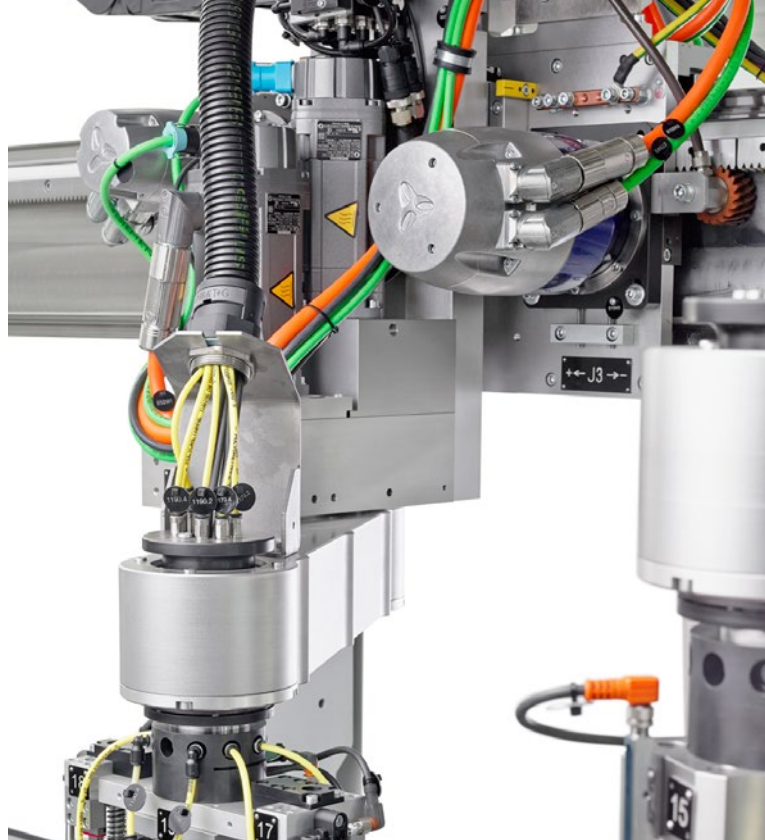

smooth running at the output, plus a very low noise level, with both the super-fast TPM+ dynamic and the high-torque TPM+ power. Finally, a movable lubricating pinion ensures an optimal lubricant film on the rack and the pinion – prolonging the life of the entire rack-and-pinion system.

Muscle packed solutions for more productivity

"Thanks to the servo actuators we got from our partner, WITTENSTEIN motion control, the system is better than ordered", Jacques Hess confirms. It's no wonder that the engineers at SECKLER have vowed to put their trust in the muscle packed servo actuators in the TPM+ series again in the future.

SECKLER modulo handling cell used to fit a grinding machine with an integral brush deburrer.



WITTENSTEIN bastian GmbH

can draw on extensive expertise in the development and manufacture of high speed, high torque and low noise gearheads adapted to almost any requirements.

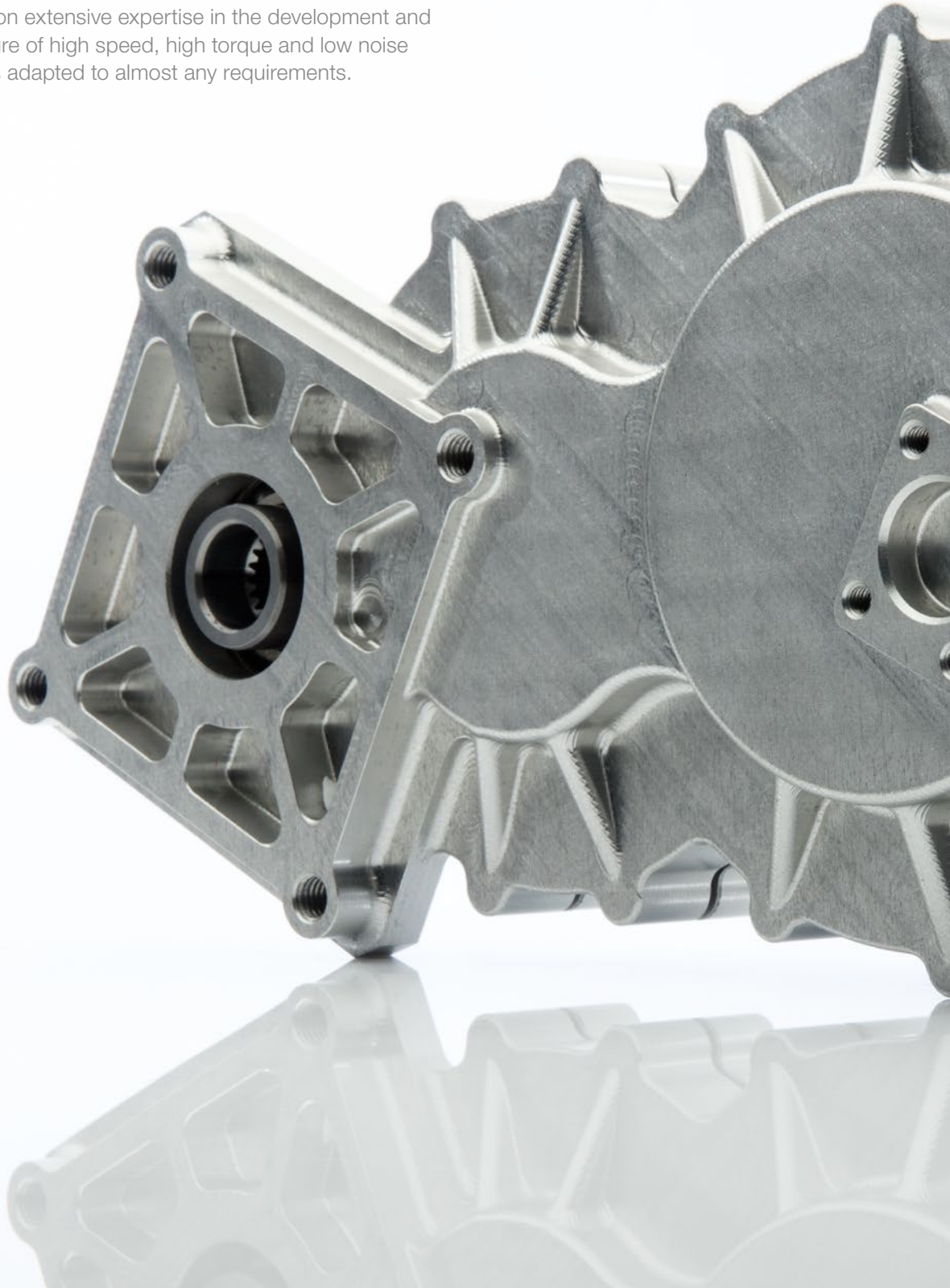

Bespoke gearheads **from a single supplier**

Gearheads with a maximum speed of 100,000 rpm are pushed to the limits as regards lubrication, bearings, operating temperature and shaft dynamics. The highest levels of development and manufacturing expertise are therefore called for when designing gearheads for operation at such high speeds. WITTENSTEIN bastian has a long track record of success here.



This 2-stage spur gearhead guarantees top performance in electric motor racing: the customer is delighted with the maximum 13,000 rpm speed. The outer casing is made of aluminium, which reduces the weight of this bespoke, special-purpose gearhead.



The gearheads are built at the “Future Urban Production” facility in Fellbach, where excellent engineering and manufacturing capabilities are combined under one roof – from the original idea to series production.



»Every year, 1.4 million gear wheels are manufactured and around 5000 gearheads assembled at the **Future Urban Production** facility in Fellbach.«

DR. MARIA HERGESELL,
HEAD OF TECHNOLOGY MANAGEMENT,
WITTENSTEIN BASTIAN GMBH

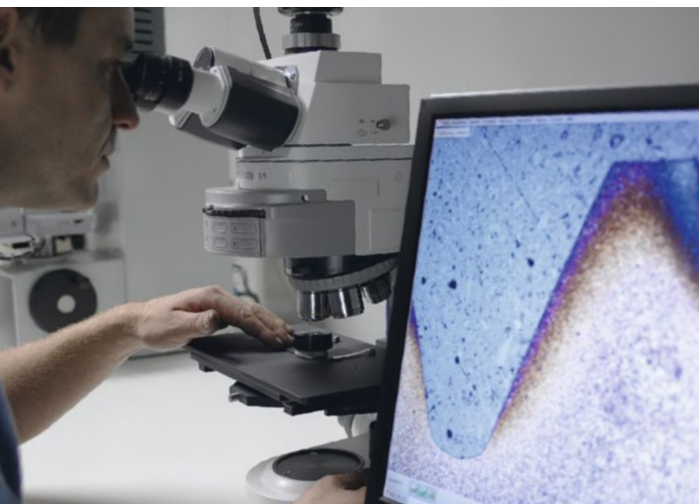

The quality of every gear wheel batch is verified by experienced staff in our own materials test lab after it leaves the heat treatment line. We analyze the material composition, surface hardness and hardness depth curve – and we also carry out an optical analysis of the structure on an etched specimen on request.

Mechanical or electrical energy production from a turbine is a typical application of high speed gearheads. The very high speeds of up to 100,000 rpm have to be reduced here with a gearhead to enable the mechanical power to be utilized directly or converted to electricity by a generator. Standard catalogue gears are totally unsuited for applications of this kind. “Special-purpose gearheads have to be developed that come up to the industry’s expectations for efficiency, load carrying capacity and operating life. An ultra-compact design and light weight are also important for mobile applications”, reports Dr. Maria Hergesell, Head of Technology Management at WITTENSTEIN bastian GmbH.

Development

As the first step in the development of special gearheads at WITTENSTEIN bastian, the technical details are clarified with the customer. The specification which is agreed in this way forms the basis for the development process. In particular, the design objectives must be defined and prioritized. Close consultation between the Engineering team and Production is a key feature of all development activities at WITTENSTEIN bastian.

“When designing a high speed gearhead, it’s imperative to consider the specialized requirements with respect to the teeth, material and bearings. All machine components like shafts, shaft-hub couplings or bearings are designed by us using generally accepted analytical



As the first step in the development of high-end gearheads and gear wheel solutions at WITTENSTEIN bastian, the technical details are clarified with the customer.



In the Class 2 precision measuring room according to VDI / VDE 2627, with Klingelnberg and Zeiss measuring machines, WITTENSTEIN bastian checks that every single tooth, shaft and housing conforms to the highest quality standards.

or numerical methods”, says Dr. Maria Hergesell when asked to describe the various development steps. Many years of experience and a sound theoretical foundation are vital in order to optimize the load carrying capacity, efficiency and noise excitation of spur and bevel gears. Commercial tools such as KissSoft, FVA-Workbench, Bearinx or Ansys are chosen for the calculations. In some cases, proprietary strategies to support the design process have been translated into self-written programs. The components are modelled using Siemens’ NX 3D CAD system. Production-compatible drawings with definitions of the required contact and clamping surfaces are derived from these virtual gearhead models in cooperation with Production and Quality Assurance. Only very little runout is allowed with high speed gearheads owing to the high, additional dynamic forces. Where possible, existing tools and workholders are resorted to for designing and manufacturing prototypes. If special tooth geometries are unavoidable, they are achieved using the most flexible production methods such as profile or generating grinding with line-by-line dressing or five axis milling.

Manufacturing

Every year, 1.4 million gear wheels are manufactured and around 5000 gearheads assembled at the “Future Urban Production” facility in Fellbach. “All machining steps are completed on the premises: turning and milling, hard turning, cylindrical grinding, gear milling,

gear slotting, generating or profile grinding and joining”, Dr. Maria Hergesell continues. The in-house heat treatment line, on which gear wheels can be quenched and tempered, case hardened and frozen, is another core process at WITTENSTEIN bastian. The surface hardness and hardness depth curve of every hardened batch are verified in our own materials test lab. In addition, an optical analysis of the structure can be carried out on an etched specimen on request. In the Class 2 precision measuring room according to VDI / VDE 2627, with Klingelnberg and Zeiss measuring machines, WITTENSTEIN bastian checks that every single tooth, shaft and housing conforms to the highest quality standards. Based on the results, the gearhead can then be optimized for production use in collaboration with Engineering, Production and the customer.

A thorough knowledge of drive technology is essential to develop bespoke, special-purpose gearheads for high performance requirements or extreme operating conditions. Yet it is equally important not to lose sight of manufacturability. WITTENSTEIN bastian unites the necessary expertise with excellent manufacturing capabilities. The combination of engineering and production under one roof also saves considerable time during the development process. The potential industries and applications are practically unlimited.



No chance for germs

Hygienic design by WITTENSTEIN

Anyone who enjoys cooking – from budding kitchen maestro to star-rated chef – knows that cleanliness and hygiene are indispensable in the presence of food. The biggest differences when it comes to industrial manufacturing and packaging of food products are the colossal amounts that are processed and packed automatically and the global reach of many convenience products. In the worst case, therefore, hygiene risks and health hazards have a global dimension – for instance, if foodstuffs perish. Impeccably clean and spotless machinery and equipment, open machine concepts and often complete asepsis or absolute sterility are stipulated for this reason.



The Hygienic Design version of the cyber dynamic line (at the back in the photo) was developed by WITTENSTEIN cyber motor as an industry-standard brushless DC motor to facilitate hygienic drive automation in production and packaging machines.

cyber dynamic line

Maximum hygiene in the fight against microorganisms

To achieve these goals, the production and packaging equipment used in food processing and beverage bottling applications or in the manufacture of pharmaceutical products must be cleaned regularly, in other words covered with lather and sprayed down with aggressive fluids. Steam and high pressure cleaners destroy even the most stubborn accumulations of bacteria. However, this places above-average demands on the automation components installed in the machines, for example on the gearheads and servo actuators. At the same time, the heavy stresses must not cause the latter to fail because the industry expects the highest levels of performance and availability both from the plant itself and from its components. The answer: corrosion resistant, hygienic solutions from WITTENSTEIN that are characterized by optimal dynamics, precision and reliability no matter how harsh the surroundings.

What is hygienic design?

Hygienic design is a combination of well thought-out design features and appropriate materials. Housings with a hygienic design are completely free of gaps, corners and protruding screw heads that could provide a breeding ground for microorganisms. Other characteristics of hygienic designs are smooth surfaces, rounded edges and non-horizontal surfaces where cleaning materials and disinfectants can drain off freely after working in and being rinsed with water.

Stainless steel is recommended for exterior housing surfaces where particularly rigorous cleaning requirements apply. As well as being extremely resistant to cleaning materials and disinfectants, stainless steel surfaces are conducive to the death of microorganisms. Electropolished and rolled stainless steel is as smooth as glass, so that no particles can adhere to the surfaces and cleaning materials can drain off without leaving any residues.

In many cases Teflon (PTFE) – resistant to cleaners and approved for food contact – is the material of choice for sealing gearheads and servo actuators hygienically.

Standards, directives and recommendations

Hygienic design is governed by an international, complementary set of standards, directives and recommendations.

The following are binding in Europe:

- Requirements of the Machinery Directive 2006/42/EC
- EU basic regulation 178/2002 on food safety
- Regulations 1935/2004 and 2023/2006 on materials and articles intended to come into contact with food

Various supportive standards also exist regarding specific hygienic requirements for machinery or operating supplies and consumables as well as the design recommendations of the European Hygienic Engineering & Design Group (EHEDG).

WITTENSTEIN implements all legal requirements and recommendations systematically worldwide. WITTENSTEIN alpha and WITTENSTEIN motion control are EHEDG members.

The HDV Hygienic Design series by WITTENSTEIN alpha are currently the only planetary gearheads of their kind with EHEDG certification.

HDV

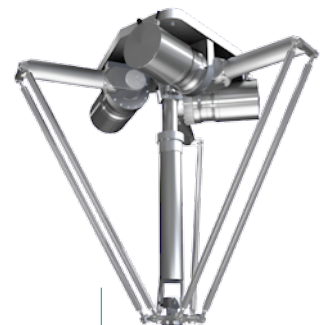

WITTENSTEIN's space saving solutions enable hygienic drive automation in the gripper of a pick & place robot.

WITTENSTEIN motion control's **axenia value** series of hygienic servo actuators made of full stainless steel are ideal for use in the food processing and packaging industries.

axenia value



Cutting-edge hygienic gearheads, servo motors and servo actuators

During the last few years, the WITTENSTEIN Group has built up specific expertise in hygienic design: The Hygienic Design version of the cyber dynamic line product family, for instance, was developed by WITTENSTEIN cyber motor as an industry-standard brushless DC motor to facilitate hygienic drive automation in production and packaging machines in the pharmaceutical, food processing and cosmetics industries. It can be integrated directly in axes where space is a critical factor, such as the gripper of a pick & place robot. The HDV Hygienic Design series by WITTENSTEIN alpha are currently the only planetary gearheads of their kind with EHEDG certification, providing the highest possible protection against product and process contamination risks. Customers seeking hygienic servo actuators made of full stainless steel as motor / gearhead units from a single supplier can choose WITTENSTEIN motion control's axenia value series as a complete, optimally interacting system conforming

to EHEDG design guidelines. Finally, premo – the new, scalable servo actuator platform – will in future be offered with industry-specific “wash” and “food” packages as corrosion resistant, hygienic solutions for the food processing, bottling and packaging industries.

Rising demand for hygienic designs

The demand for machines with a hygienic design will continue to rise, not least because changing consumer habits are already leading to a steadily growing array of individually wrapped or single-serving food and convenience products. Hygienic designs simultaneously minimize the risk of high direct and indirect costs to food and pharmaceutical manufacturers or bottling and packaging specialists if contamination results in machine stoppages or – even worse – a recall campaign causes untold damage to the company's brands and image. Awareness of the benefits of hygienic design is increasing – and with it the demand for hygienic drive technology made by WITTENSTEIN.



»Going on the road gave me a more cosmopolitan outlook and made me a more independent and relaxed person.«

PATRICK ROMMEL,
TECHNICAL SALES SUPPORT
WITTENSTEIN ELECTRONICS GMBH

In the Andes a different sense of time applies

On the road in Peru



Stock.com/chabnek



Stock.com/mersu.krugoku

He was on the road for three months, during which he travelled over 5500 miles – most of them in more than 130 hours on long-distance coaches, often overnight. His chosen project was on the subject of technical training in Peru and the intensive contact with the country and its people taught him many valuable lessons: Patrick Rommel used to study at a Cooperative State University in tandem with WITTENSTEIN and meanwhile works in Technical Sales Support at WITTENSTEIN electronics. His personal conclusion: “Going on the road gave me a more cosmopolitan outlook and made me a more independent and relaxed person”.

Patrick Rommel is one of 45 trainees and Cooperative State University students since 2011 to have taken part in WITTENSTEIN’s “PIONEERS hit the road” programme after completing their training or degree course. In a land of their choice and with a project initiated by them, young adults have a chance to form their own impressions of the country and its people – of its politics, culture, society and geography.

To date, all of them have returned with valuable insights for their future lives and their personal development – and Rommel is no exception: “My period on the road was a unique experience and the lessons I learned during my three months as a ‘journeyman’ will stand me in good stead on my professional and private path.” Peter Schuster, Sales Manager at WITTENSTEIN electronics GmbH, agrees unequivocally with this statement: “I firmly believe that going on the road generates important stimuli for the development of the youngsters’ personality – both in general and in his particular case. Individual responsibility, a willingness to take decisions and the ability to understand what motivates people and influences their

attitudes are things that will help him both in his private pursuits and in his job here in Technical Sales.”

Technical training in Peru

Why Peru of all places? “To begin with, it was more of a privately motivated decision”, Patrick Rommel recalls. “I then started to take a closer look at the country, to gather information and study reports. They strengthened my conviction that Peru was the place for me because a totally new situation would await me there – which is how it should be for a pioneer.” The subject he selected for his project while on the road was technical training in Peru. Following countless interviews, conversations and visits to training institutions, he insists that it was an altogether exciting topic. The start, however, was bumpy, to say the least: “I found it almost impossible to establish contacts and arrange appointments by phone or online from Germany”, Patrick Rommel recollects, and there were many moments of frustration before the ball finally began to roll. “But when I finally arrived in Peru, I’d only been there a few days when I received an invitation from Alf Buddecke, the Director of the Vocational Centre at the

PIONEERS hit the road

With its “PIONEERS hit the road” project WITTENSTEIN has revived a medieval tradition. The tradition of taking to the road – the “journeyman years” – was originally partaken in by youngsters who had completed their apprenticeship as a craftsman. From the late Middle Ages to the early period of industrialization, it was one of the prerequisites for any apprentice aspiring to be promoted to master. Journeyman were expected to profit from their time on the road to become acquainted with new working practices, get to know foreign places, regions and countries and gain experience that would stand them in good stead for the rest of their lives – exactly like the young WITTENSTEIN pioneers today. They spend about three months travelling around the country of their choice and gathering information on a subject that particularly interests them.



Patrick Rommel looks down on Macchu Picchu, the world-famous ruined city, 2720 metres above sea level.

Humboldt School in Lima.” It proved to be a win-win visit: Patrick Rommel came away with some useful tips and contacts, which he availed of to build up an interview network over the next few weeks. In return, he was able to organize a direct contact with WITTENSTEIN, and a pupil from the Humboldt School will be undertaking a placement at our Headquarters in Igersheim later this year.

Technical training in Peru: “typically German” is not such a bad thing

Patrick Rommel also picked up valuable information during conversations with the German-Peruvian Chamber of Commerce, SENATI – a semi-publicly funded educational institute with branches all over the country – and Faber-Castell, the stationery manufacturer, which employs seven hundred people at its production facility in Lima. The results of his investigations are not really surprising: people’s perceptions of training quality and the reasons for shortcomings vary according to their point of view. Patrick Rommel: “Those who can afford to pay for education and training have a definite advantage”. He himself was regarded as a rather exotic creature everywhere he went: “Hardly anyone could understand how I could be a qualified engineer so young. Not only that, I was even earning money while I was still training.” This was just much a culture shock for Patrick Rommel himself as it was for the people he interviewed. It took him a while to take in and fully comprehend their reactions: “It taught me that we take a lot of things in this world for granted, yet for many people they’re completely out of reach”. He also learned from this and similar experiences to see his own system of cultural values with slightly different eyes. “It may sound very old-fashioned but

typical German virtues like punctuality, reliability and orderliness can make life a lot easier, at least in a business environment. The Peruvian mentality is quite the opposite, which probably goes a long way towards explaining the current situation in technical training”.





The impressive skyline of Lima, the Peruvian capital

Learning to stay cool

Patrick Rommel doesn't have to think long when asked how he himself has changed as a result of going on the road: "The ability to stay cool. I can cope better with uncertainties now and react in a much more relaxed way to the unexpected. I'm also better equipped to take my own decisions and if I need to weigh up several alternatives, I can distinguish more easily between arguments that matter and those that don't." And of course, his intercultural skills are no comparison to the old days before he went on the road: "You develop an awareness of other cultures and other people. That's a vital asset if you want to understand their actions and motives, their lifestyles, their opinions and feelings or their problems in different situations and respond to them accordingly."

Cosmopolitan, independent and relaxed – these qualities will serve Patrick Rommel in good stead both privately and in his job in Sales.

Patrick Rommel learned a lot about technical training in Peru at SENATI, a semi-publicly funded educational institute.





WITTENSTEIN

Sicherheit in der mechatronischen Antriebstechnik
Secure mechatronic drive technology



Trade fair calendar 2016

Hannover Messe

Hanover (Germany)
WITTENSTEIN Group
Hall 15, Stand F08
April 25 to 29, 2016

OTC

Houston / Texas (USA)
WITTENSTEIN motion control GmbH
Hall B, Stand 4527-29
May 2 to 5, 2016

FEIMEC

São Paulo (Brazil)
WITTENSTEIN do Brasil
May 3 to 7, 2016

IFFA

Frankfurt (Germany)
WITTENSTEIN Group
Hall 11.0, Stand A18
May 7 to 12, 2016

SMART

Vienna (Austria)
WITTENSTEIN GmbH
Hall A, Stand A0125
May 10 to 12, 2016

SPS IPC Drives

Parma (Italy)
WITTENSTEIN S.P.A.
Hall 2, Stand E062
May 24 to 26, 2016

Xylexpo

Milan (Italy)
WITTENSTEIN S.P.A.
May 24 to 28, 2016

BIEMH

Bilbao (Spain)
WITTENSTEIN S.L.U.
May 30 to June 4, 2016

ILA Berlin Air Show

Berlin (Germany)
WITTENSTEIN aerospace & simulation GmbH
Hall 2, BDLI Pavilion
June 1 to 4, 2016

all about automation

Friedrichshafen (Germany)
WITTENSTEIN alpha GmbH
Hall A2, Stand 209
June 7 to 8, 2016

Eurosatory

Paris (France)
WITTENSTEIN motion control GmbH
Hall 6, German Pavilion
June 13 to 17, 2016

The 21st Beijing Essen Welding & Cutting Fair

Beijing (China)
WITTENSTEIN (Hangzhou) Co., Ltd.
June 14 to 17, 2016



WITTENSTEIN is represented at numerous trade fairs and exhibitions worldwide.
We look forward to meeting you!

China International Robot Show

Shanghai / Hongqiao (China)
 WITTENSTEIN (Hangzhou) Co., Ltd.
July 6 to 9, 2016

Farnborough International Airshow

Farnborough (UK)
 WITTENSTEIN aerospace & simulation GmbH
 Hall 4, Stand F120
July 11 to 17, 2016

AMTS

Shanghai / Pudong (China)
 WITTENSTEIN (Hangzhou) Co., Ltd.
August 24 to 26, 2016

NEPCON Presentation Microelectronics South China

Shenzhen (China)
 WITTENSTEIN (Hangzhou) Co., Ltd.
August 30 to September 1, 2016

Taipei International Industrial Automation Exhibition

Taipei (Taiwan)
 WITTENSTEIN Co., Ltd.
August 31 to September 3, 2016

Sindex

Berne (Switzerland)
 WITTENSTEIN AG
September 6 to 8, 2016

World of Technology & Science

Utrecht (Netherlands)
 WITTENSTEIN bvba
October 4 to 7, 2016

BI-MU

Milan (Italy)
 WITTENSTEIN S.P.A.
October 4 to 8, 2016

Motek 2016

Stuttgart (Germany)
 WITTENSTEIN Group
October 10 to 13, 2016

